

THE EXPERT OF LCD AND LCM
CLOVER DISPLAY 高發液晶
 Standard LCD Modules
 Standard LCD Panels
 Custom Design
 Demonstration

TOTAL SOLUTION

Customer's SPECIFIC NEEDS

LCD Display Module
 Touch Panel



PCB

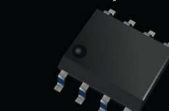

MCU

Assembly

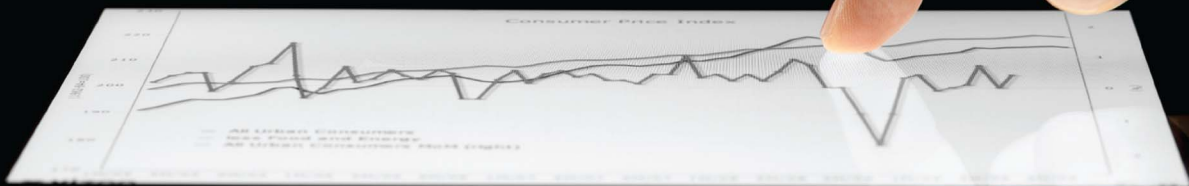

THE EXPERT OF LCD AND LCM



Starting off as an associated company of Kontoy Products Company Limited, which focused on electronic board assembling, Clover Display Limited was established in 1983. Clover developed its business in LCD manufacturing and chemical engineering production, processes which are very hard to perfect, but Clover attains the impossible.

Clover (trefoil) usually has three leaves, but occasionally it has four leaves, a probability of 1 in 1000. The four-leaf clovers, like other rarities, are considered as lucky. A common idiom is "to be in clover", which means to be living in a carefree ease, comfort or prosperity. The four leaves clover symbolizes that Clover Display never gives up in developing new applications for different products. We are competitive and perseverant, despite different challenges and hardships.

A strong R&D team in Hong Kong allows Clover to continuously develop LCD and LCM for new applications. In 1993, a 8000 square meter factory was established in Shunde, which specialized in custom design LCD and LCM for industrial applications.

Facilities in Hong Kong and Shunde mainly focus on industrial applications, such as control units, energy meters, equipments, automotives, health equipment, medical equipment, home appliances, fax machine, feature phone, sport coaching meters, thermostats , etc.

In March 2001, Clover China Display (Shenzhen) Limited was established and mainly targeted at China and Taiwan local markets of commercial type.

Market

Clover's sales networks do not only cover Asia, but also Europe and North America. Cooperating with our partners, we make use of their local sales networks to sustain worldwide brand development.

Quality Standard

Our production lines and facilities have met the standard of ISO 9001 and ISO 14001 to ensure our products and service quality.

China Plant for Overseas Market

Longoal Display Limited

The LCD and LCM production at Longoal represents the very best in manufacturing and enables competitive pricing for the world market.

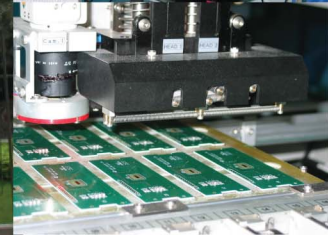

高華電子顯示(深圳)有限公司 CLOVER CHINA DISPLAY (SHENZHEN) LIMITED

本集團高發成立於1983年，管理層前身是從事電子線路裝配，剛達製品有限公司。集團的主要業務是設計和生產液晶顯示屏；此化工生產是易學難精。

紅花草 (Clover)，又或是三葉草，通常只有三塊葉，只有1000份1的機會會出現四葉；與其他稀有品種一樣，四葉紅花草被視為好運；外國有一句諺語「To be in clover」，意思是生活優裕、無憂無慮；四葉紅花草(Clover)標誌著高發集團致力於為產品開發不同的應用範疇，從不放棄，就算面對不同的挑戰及困難，仍然鍥而不捨。

高發液晶在香港設有一隊強大的研發團隊，讓高發液晶可以持續地研發液晶顯示器 (LCD) 及液晶顯示屏 (LCM) 的新應用。在1993年，我們在中國順德設立八千平方米的工廠，專門開發為客戶度身訂做的LCD及LCM作工業應用，為海外客戶 (OBM, Original Brand Manufacturing) 生產特定要求的LCD及LCM。

90年代中國工業崛起，本集團有見及此，於2001年在深圳南山區設立高華電子顯示(深圳)有限公司，以獨資經營方式服務中國內銷客戶，並可開具增值稅發票，以人民幣結算。深圳高華的生產線及工廠得到ISO 9001認證，所以我們的產品及服務同樣屬於高質素。

深圳高華主攻商業和消費性產品，包括能量錶(energy meters)、儀器(equipment)、家電(home appliances)、特色電話(feature phones)、自動恆溫器(thermostats)、玩具(Toys)、音響設備(Audio Equipment)、指紋機(Finger Prints)等。

Management Team

深圳高華管理層

A professional and experienced Management team overlooks Sales and Administration, Manufacturing and quality control in Hong Kong and China respectively. Of course, Group's consultant keeps on providing technological advice.

專業及富有經驗的管理團隊來自香港，管理深圳的銷售及行政、生產及品質管理，同時香港公司的顧問會為深圳高華提供專業技術意見。

China Plant for China & Asia Market

深圳高華市場

Clover China Display (Shenzhen) Limited

The full line Lcd production services the China & Asia markets .

深圳高華銷售網絡主要為中國及亞洲(日本除外)，我們更與萬保剛集團合作，於上海，北京，福州，香港，台灣，馬來西亞，泰國，菲律賓和南非等地成立LCD應用中心，加強與客戶互動，提高我們的產品應用於消費電子產品、測驗儀器、玩具及通訊等。透過他們的本地銷售網絡去建立我們的品牌。



Certificate CN10/30105



SPECIALIZED in Custom Designed Products

- Standard LCD Panels and Modules
- Custom Designed LCD Panels and Modules
- Touch Panel
- Module Circuit Design
- OEM Manufacturing
- TN, HTN, STN, and FSTN
- EBTN
- FSC (Field Sequential Color)
- Shaped LCDs
- Using Ultra Thin Glass
- Black Masking
- Color Printing Technique
- SMT, COB, Slim Type COB, TAB, and COG
- Led Backlighting solution

High Resolution Graphic Modules and Custom Made

One Chip Solution for 320 x 240 COG Graphic LCD Module

Features

- Single chip supporting high resolution
- Built-in controller
- Cost effective

Applications

- Indoor telephone
- Printer / Scanner / FAX machine
- POS terminal
- Educational equipment

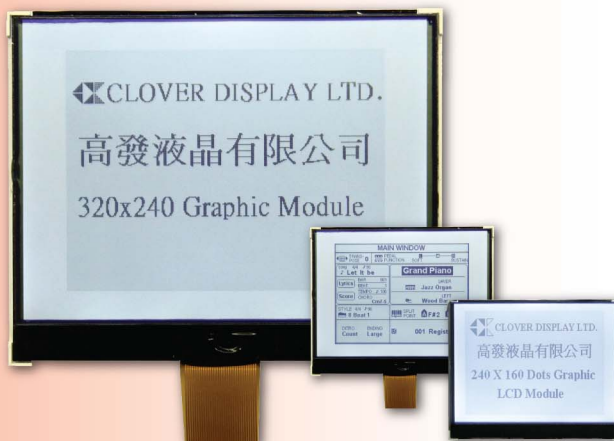

Segment Type COG

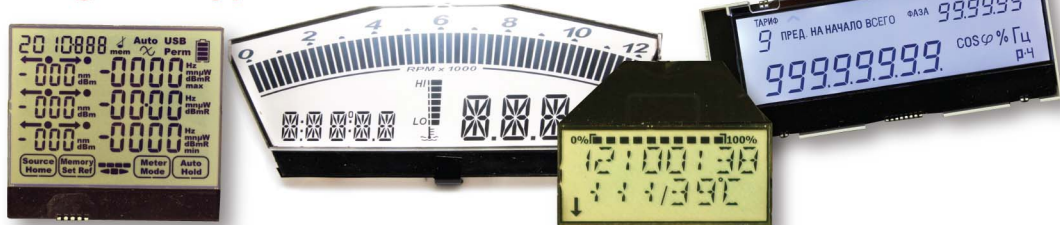

Large Graphic Model



RGB Backlight

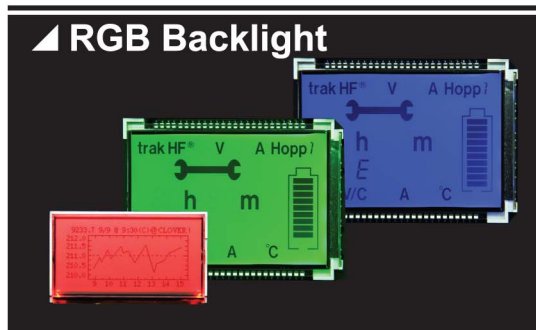

EBTN

Enhanced Black Twisted Nematic

EBTN

EBTN (Enhanced Black Twisted Nematic) LCD technology is the one of the best negative image display with super high contrast ratio of 500:1, exceeding conventional negative TN, STN and FSTN technology. Their high performances make it an ideal choice for applications ranging from watches to automotives.

Features

- Very dark background with low light leakage
- Super high contrast (500:1)
- Wide viewing angle (3-side optimized)
- Wide operating temperature (-30°C ~ 80°C)
- No temperature compensation required
- Best for icons and 7-segment displays

Applications

- Automotives
- Audio Equipments
- Watches
- Multimeters
- Home Appliances
- Information Board

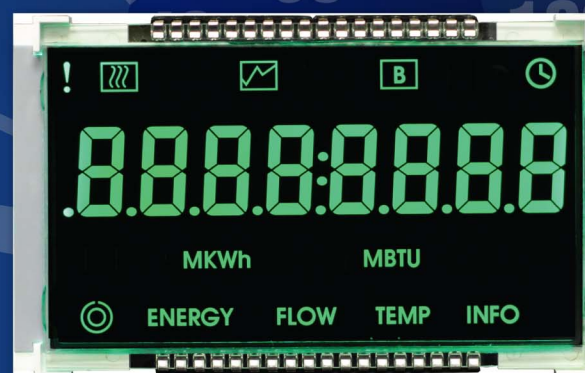

Capacitive Multi-touch Panel

“ Capacitive multi-touch panel is the best choice for high durability with multi-touch feature. This technology involves no mechanical movement on the panel when operated, as your finger acts like a capacitor which couples the balance state signal when it touches on an operating panel. When one or multiple signals are detected, your fingers' coordinates can be calculated immediately by data processing.” ”

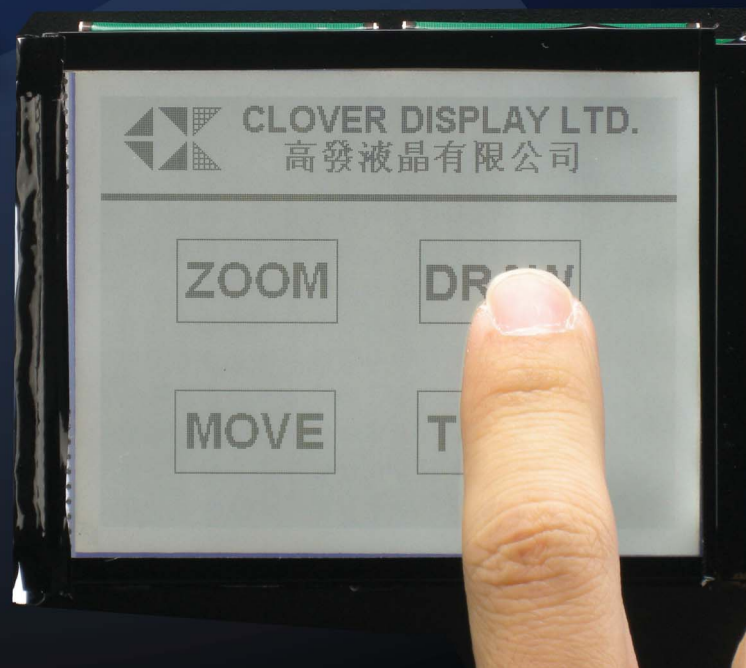
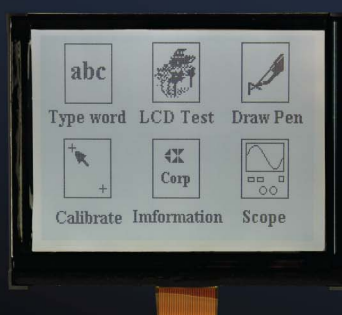



CUSTOM

Designed LCD Panels and Modules

Satisfy Your SPECIFIC Needs

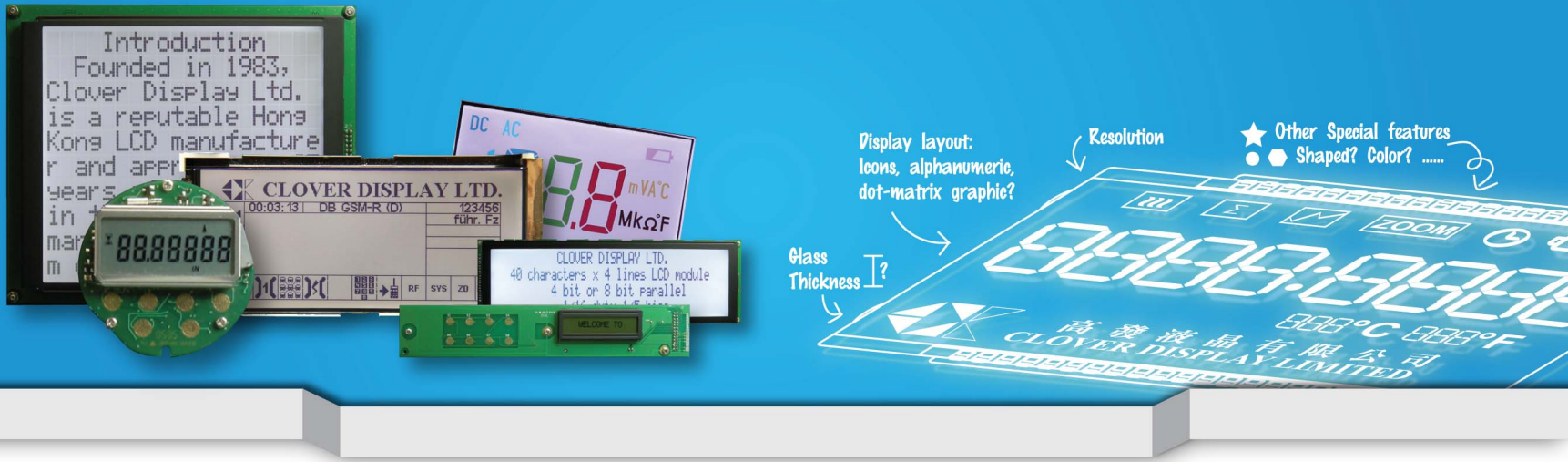

Applications

Industrial Applications, Testing Equipments and Telecommunications, etc.

Industrial Applications



Health Equipment



Energy Saving Products



Industrial UPS



Security Control Panel



Touch Screen Thermostat

Testing Equipments



Vibration/Tachometer



Force Gauge



Sound Level Meter



Environment Meter

Telecommunications



Telephone



Telephone

TOTAL SOLUTION

We provide total solution for interactive interface devices by integrating LCD display module, touch panel, MCU and PCB assembly, all in one. Such convenience allows a broad range of customer to build their own product with high flexibility and complexity.

- Automotive
- Home Appliance
- Industrial Automation
- Lighting
- Information Collection
- PC Peripherals
- Building Automation
- Home Entertainment
- Telecommunication
- Public Information System
- Metering



TOTAL SOLUTION

Customer's SPECIFIC NEEDS

LCD Display Module
Touch Panel

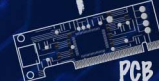

PCB

MCU

Assembly



Portable
Gadgets



Dashboard



Automotive
Home Appliance
Industrial Automation
Portable Gadgets

高發液晶有限公司
CLOVER DISPLAY LIMITED



Standard LCD Modules
Standard LCD Panels
Custom Design
Demonstration

Hong Kong Headquarter:

高發液晶有限公司

CLOVER DISPLAY LIMITED

香港 九龍 官塘 鴻圖道26號 威登中心1006室
Rm 1006, Westin Centre, 26 Hung To Road,
Kwun Tong, Kowloon, Hong Kong
Tel: (852) 2341 3238, (852) 2342 8228
Fax: (852) 2357 4237, (852) 2341 8785
Email: cdl@cloverdisplay.com

www.cloverdisplay.com

China Factories:

高華電子顯示(深圳)有限公司

Clover China Display (Shenzhen) Limited

中國 深圳市 南山區 白石洲 沙河工業區 B4棟
Block B4, Shahe Industrial Town, Baishizhou,
Nanshan, Shenzhen, China
(Postal Code: 518053), P.R.C.
Tel: (86) 755 8609 6773
Fax: (86) 755 8609 6870
Email: sales@cloverchina.com
www.cloverchina.com

龍高液晶有限公司

Longoal Display Limited

中國 廣東省 佛山市 順德區 龍江鎮 龍首工業區22號
22 Longshou Industrial Area, Longjiang, Shunde,
Foshan, Guangdong, China



Asia Distributor :

Hong Kong (香港)

7/F, New Trend Centre, 704 Prince Edward Road East,
San Po Kong, Hong Kong
Tel: (852) 2397-8218
www.mobicon.com

Fax: (852) 2397-0339, 2397-8187
Email: info@mobicon.com

China (中國)

深圳辦事處
深圳市羅湖人民南路3002號國貿大廈17樓
Tel: 86-755-8218 7824
Fax: 86-755-8221 1774
Email: china@mobicon.com

北京辦事處
Tel: 86-010-6255 8131, 86-010-6255 0752
Fax: 86-010-6256 3252
Email: mobicon_bj@mobicon.com

上海辦事處
上海市黃浦區北京東路668號科技京城群樓B區5樓525室
Tel: 86-021-5308 6389, 86-021-5308 6387
Fax: 86-021-5308 6385
Email: mobicon_sh@mobicon.com

Taiwan (台灣)

台北市內湖區114瑞光路586號7樓
Tel: 886-2-2657 9336
Fax: 886-2-2657 8030
Email: tw@mobicon.com
www.mobicon.com.tw

Singapore

50 Ubi Ave 3, #02-06 Frontier,
Singapore 408866
Tel: (65) 6747 7472
Fax: (65) 6747 6768
Email: sg@mobicon.com
www.mobicon.com.sg

Thailand

Unit 184/92, Forum Tower, 18th Floor,
Ratchadapisek Road,
Huaykwang, Bangkok 10320, Thailand
Tel: (662) 245 0231
Fax: (662) 645 3305
Email: th@mobicon.com
www.mobiconthailand.com

Philippines

37/F, LKG Tower, 6801 Ayala Avenue,
Makati City, Philippines
Tel: (632) 859 2890 / (632) 859 2891
Fax: (632) 830 8657
Email: sg@mobicon.com

Malaysia

No.36, Jalan Petaling Utama 5,
Taman Petaling Utama, Batu 7,
Jalan Klang Lama, 46000 Petaling Jaya,
Selangor Darul Ehsan, Malaysia.
Tel: +603 7783 2257
Fax: +603 7783 4316 / 4318
Email: kl@mobicon.com.my
www.icmaster.com.my

South Africa

32 Laub Street, New Centre,
Johannesburg, South Africa.
Tel: (011) 493 9307
Fax: (011) 493 9319
Email: sales@mantech.co.za
www.mantech.co.za